

## Columna Seca

### \* IPF-39 Boca de salida en piso



Cofre IPF-39



Bifurcación de 45 mm



Marco IPF-39

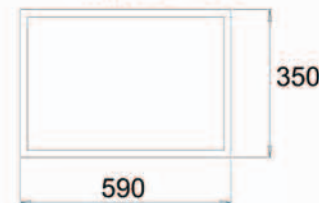
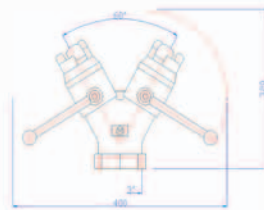
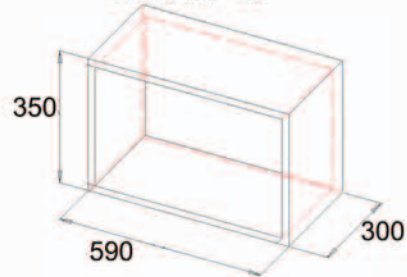

Armario o arqueta empotrada con puerta practicable o frontal rompible o marco, que contiene conexión siamesa con llaves incorporadas, entrada roscada de 2 1/2" y dos salidas de 45 mm con racores y tapas según UNE-23400 para uso normal.

### \* IPF-40 Boca de salida en piso con llave de seccionamiento



Marco IPF-40

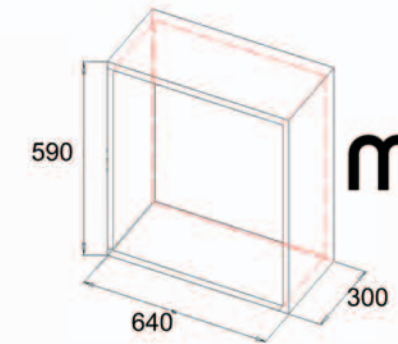
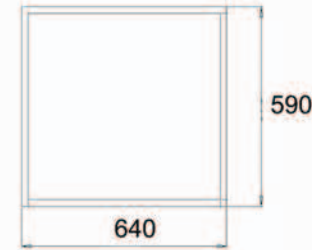

Macoin

Armario o arqueta empotrada con puerta practicable o frontal rompible, que contiene conexión siamesa con llaves incorporadas, entrada roscada de 2 1/2" y dos salidas de 45 mm con racores y tapas según UNE-23400 para uso normal. LLave de seccionamiento de 3" en aluminio.

### \* IPF-41 Toma de alimentación en fachada



Marco IPF-41

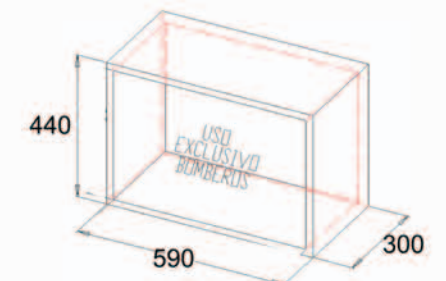
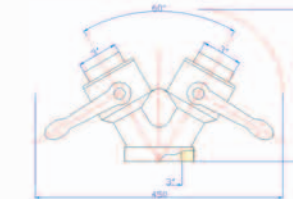

Armario o arqueta empotrada con puerta metálica, e indicación de uso exclusivo de bomberos, que contiene una conexión siamesa con llaves incorporadas, entrada roscada de 3" y dos salidas de 70 mm con racores y tapas según UNE-23400 para uso normal.



Derivador de Columna Seca y Mantenimiento

